

# Tork Foam Soap Dispenser with Intuition™ Sensor

Image  
Design

S4

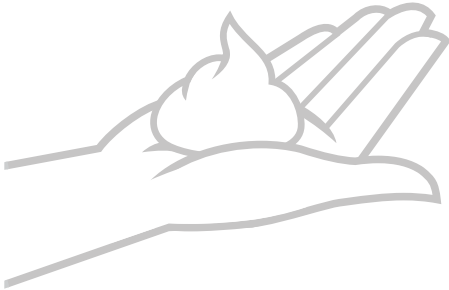
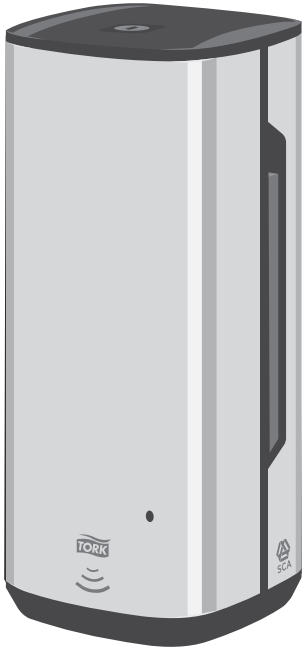

[www.sca-tork.com](http://www.sca-tork.com)



Tork Foam Soap Dispenser

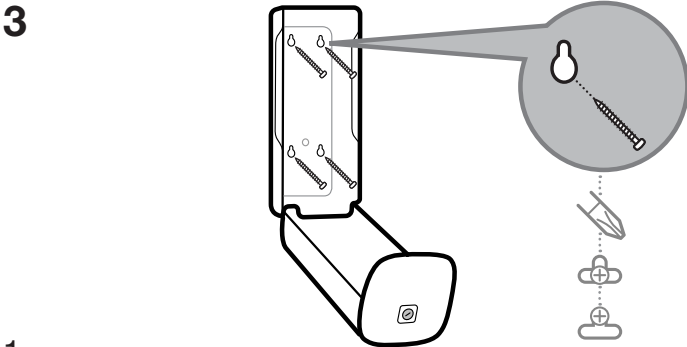
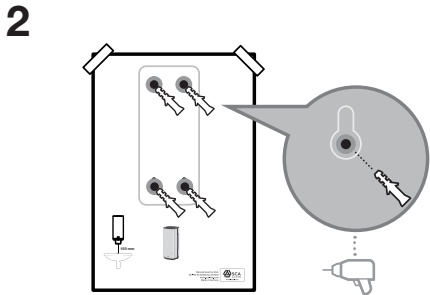
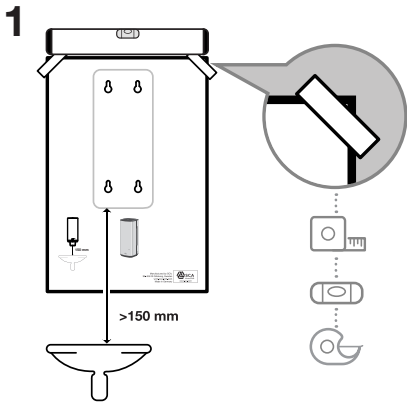
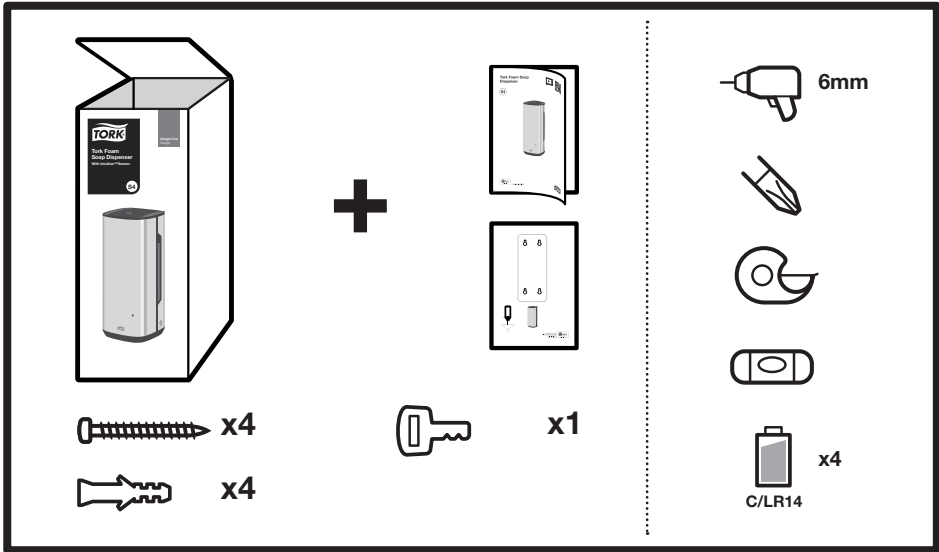

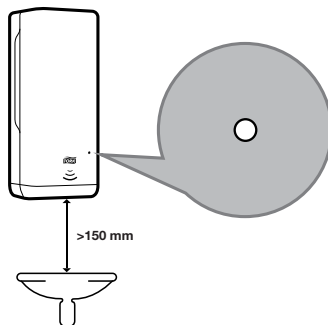
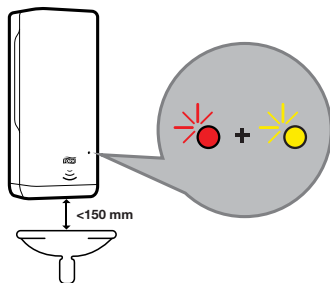
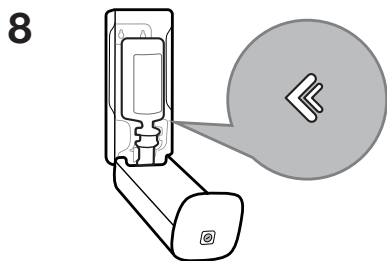
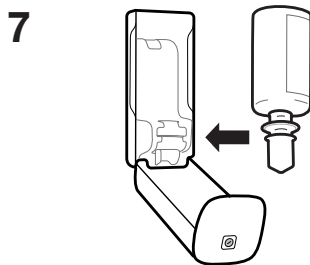
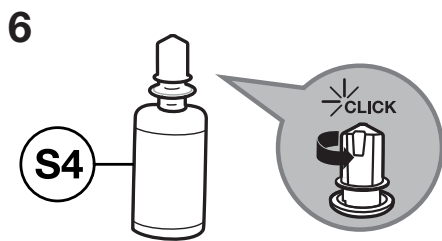
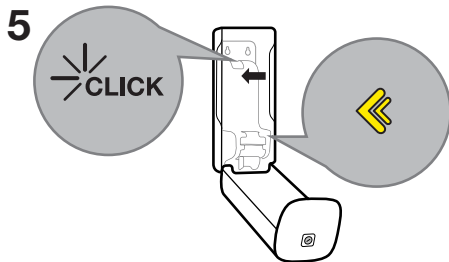
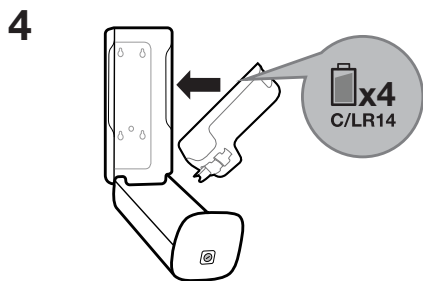

Tork Foam Soap Dispenser

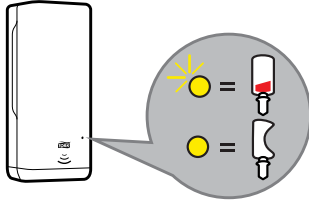

1

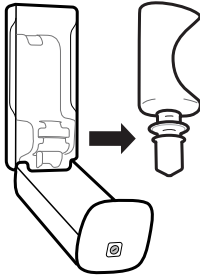

2

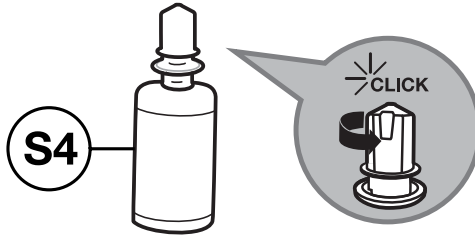

3

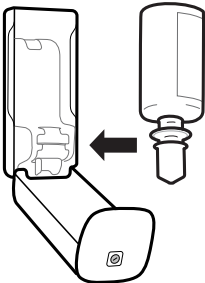

4

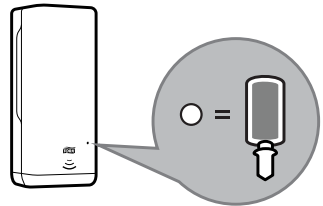

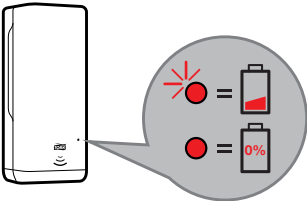

1

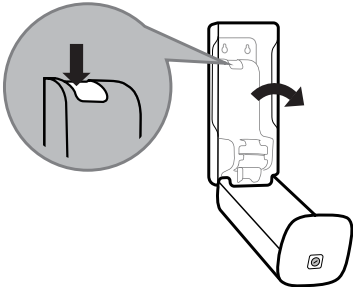

2

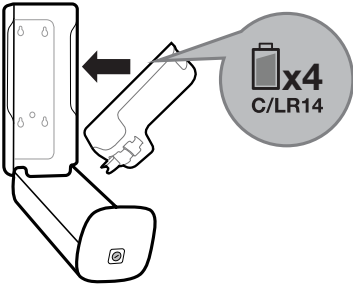

3

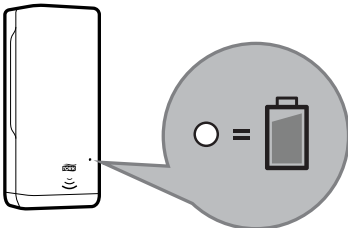

Tork Foam Soap Dispenser

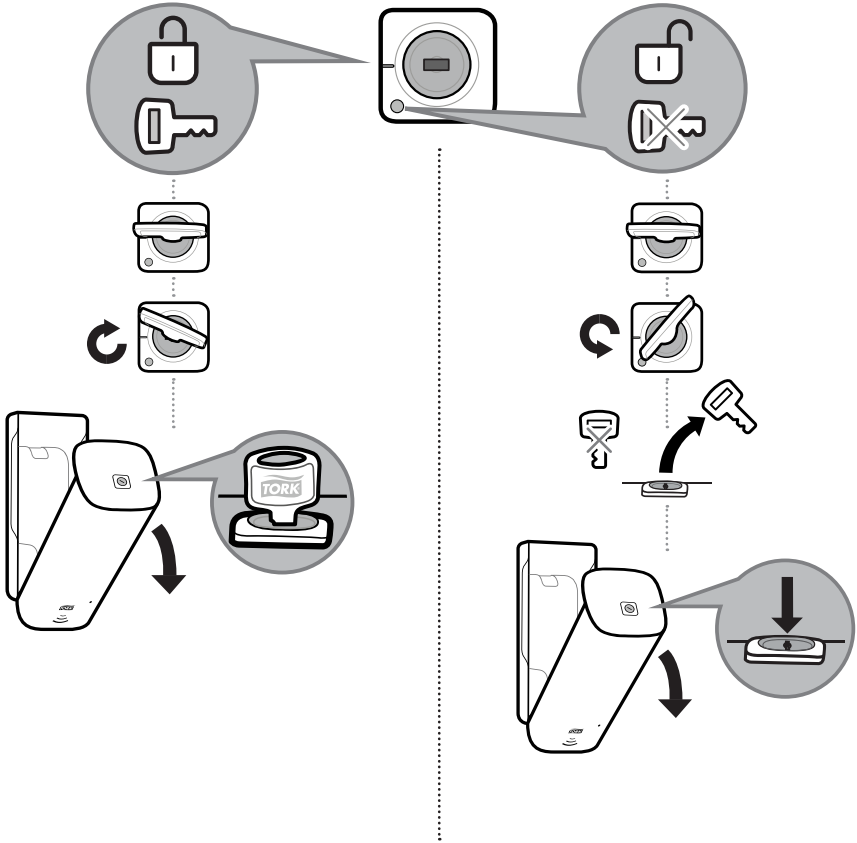



## Warnings

- Children should not be allowed to play with the appliance
- The maximum and minimum ambient temperatures for correct operation are 0 to 50 degrees Celsius (32 to 122 degrees Fahrenheit)
- This dispenser is not suitable for installation outdoors or in wet environments. It is not water-resistant
- Operating sound level of the dispenser is less than 70dBa

## Disposal

- Damaged or malfunctioning product should be disposed of immediately to avoid potential of injury
- Products should be disposed of in accordance with applicable regulations

## Cleaning instructions

- Please take necessary precautions during maintenance operations. Clean dispenser as needed. Wipe to clean using a soft, lint free towel. Use water and mild detergent (exterior surfaces only)

European community design registration RCD 002601922



Manufactured by SCA  
SE-405 03 Göteborg, Sweden  
[www.sca-tork.com](http://www.sca-tork.com)  
Made in Poland